

(B-B/W)

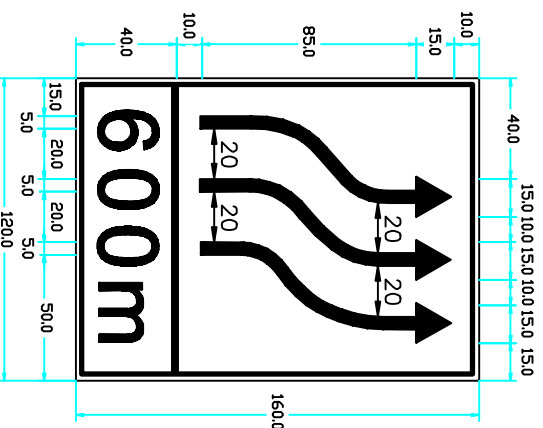

(B-B/W)

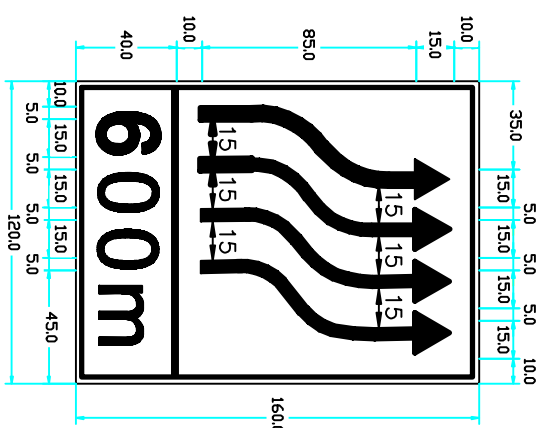

(B-B/W)

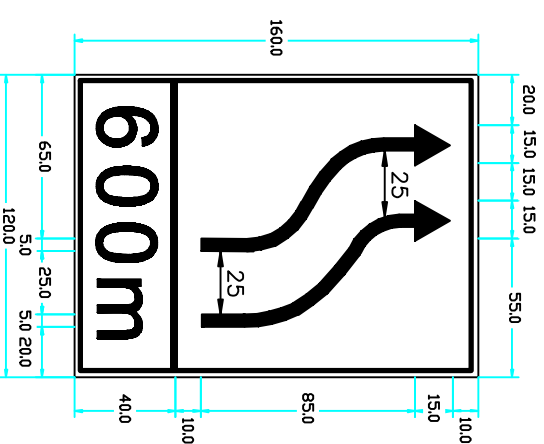

(B-B/W)

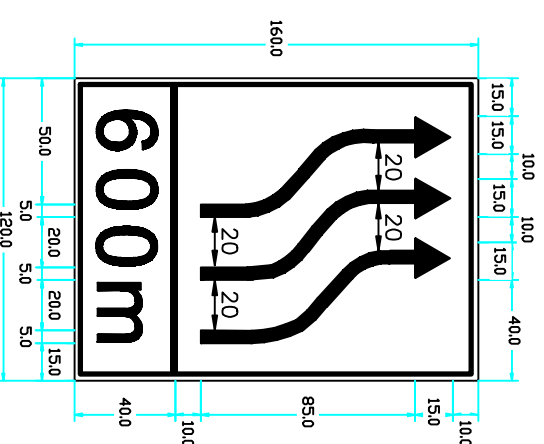

(B-B/W)

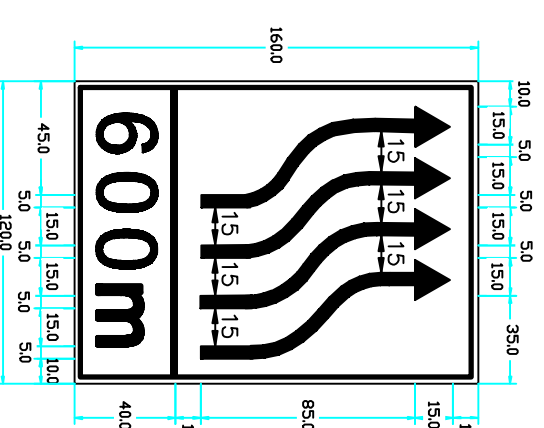

(B-B/W)

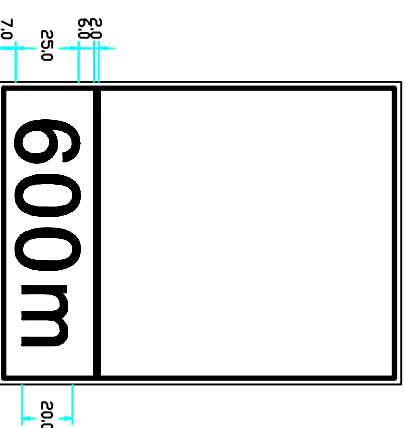

箭頭製作尺寸詳圖

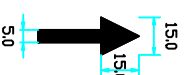

附註：

1. 複車道數劃設相對應之行車動線。
2. 配合左右側施工，調整行車動線。
3. 路肩處施工時，無需設置本告示牌圖面。
4. 牌面裡控數請依布設之實際距離標示。
5. 標誌為白底黑字黑邊。